

There is only one groove shape for all MiniTec construction profiles. Thus all fasteners are useable in all profiles, the necessary stock of fastening material can be reduced to a minimum and all elements fit to all profiles.

PROFILE SECTIONS

Profile 19 x 32



Part No. 20.1000/0

Profile 32 x 32 UL



Part No. 20.1064/0

Profile 32 x 32 F

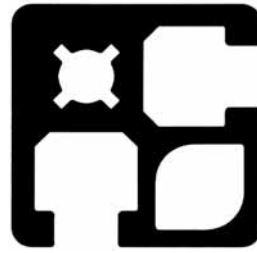

Part No. 20.1054/0

Clamp Profile 32 x 32



Part No. 20.1070/0

Profile 19 x 45



Part No. 20.1001/0

Profile 45 x 32 UL

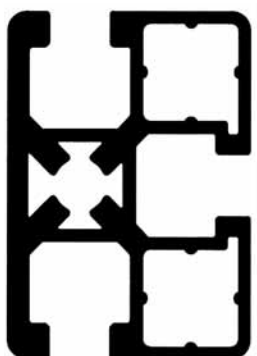

Part No. 20.1065/0

Profile 45 x 32 F



Part No. 20.1055/0

Clamp Profile 45 x 32

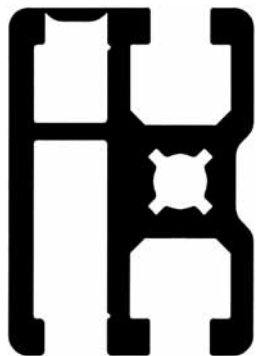

Part No. 20.1053/0

Profile 45 x 45 UL

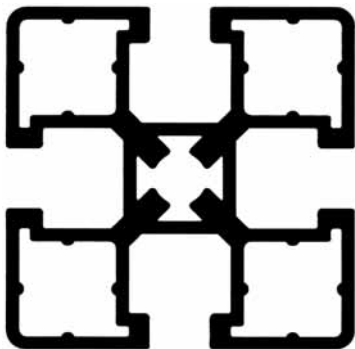

Part No. 20.1063/0

Profile 45 x 45 F

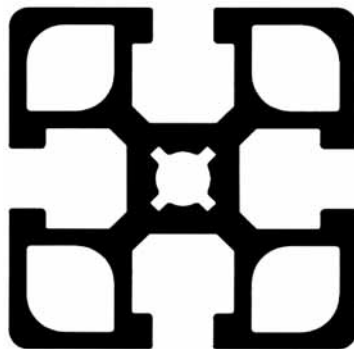

Part No. 20.1033/0

Profile 45 x 45

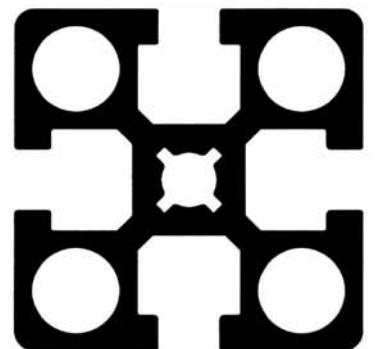

Part No. 20.1006/0

Profile 45 x 45 2G

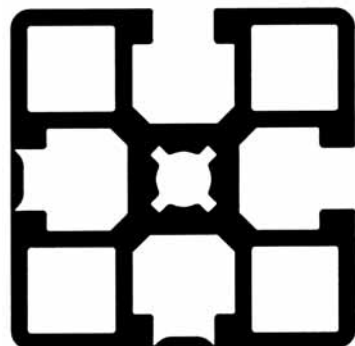

Part No. 20.1072/0

Profile 45 x 45 3G

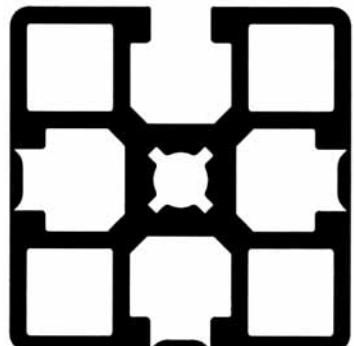

Part No. 20.1048/0

Profile 45 x 45 G

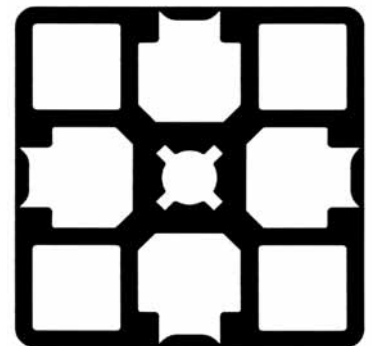

Part No. 20.1028/0

PROFILE SECTIONS

Profile 45 x 45 VA

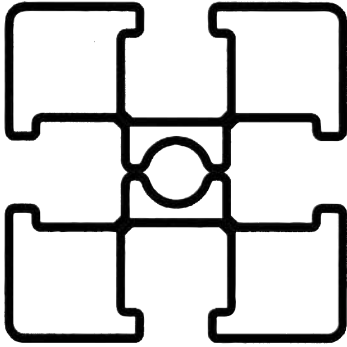

Part No. 20.2000/0

Profile 45 x 19



Part No. 20.1012/0

Cover Profile 45 x 45 R



Part No. 20.1037/0

Profile 45 x 45 R

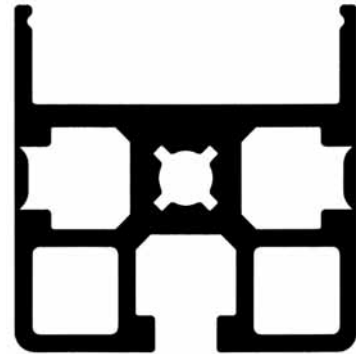

Part No. 20.1046/0

Profile 45/22,5°

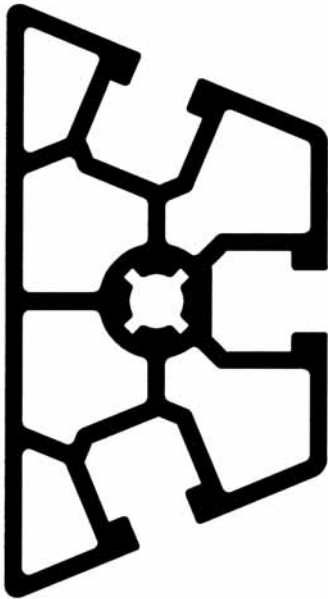

Part No. 20.1030/0

Profile 90 x 19



Part No. 20.1031/0

Profile 45 x 60

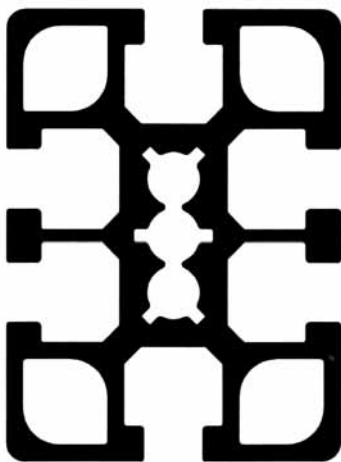

Part No. 20.1023/0

Profile 60 x 60 F

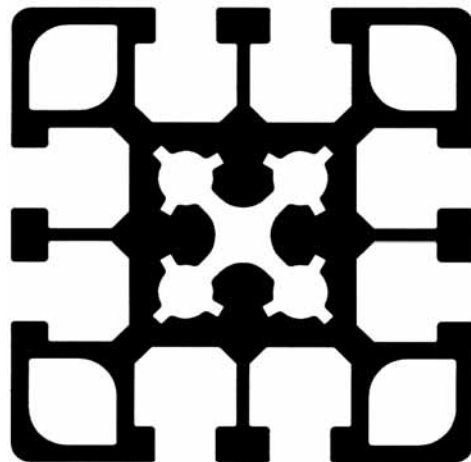

Part No. 20.1049/0

PROFILE SECTIONS

Profile 90 x 32 UL



Part No. 20.1066/0

Profile 45 x 90 UL

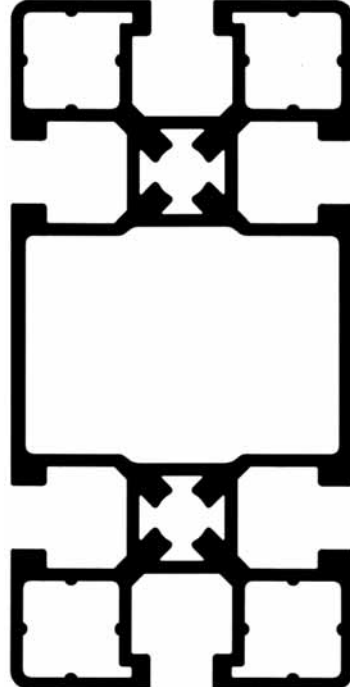

Part No. 20.1067/0

Profile 45 x 90 G

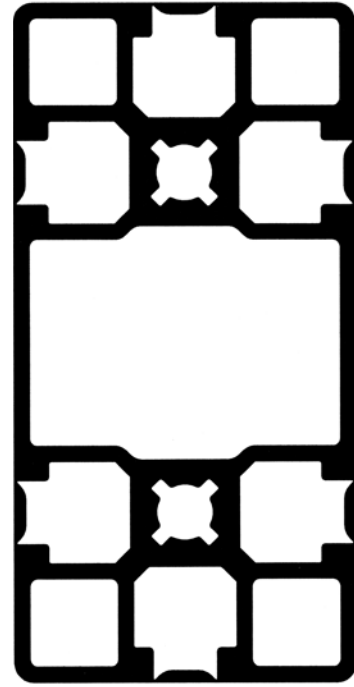

Part No. 20.1015/0

Profile 45 x 90 F

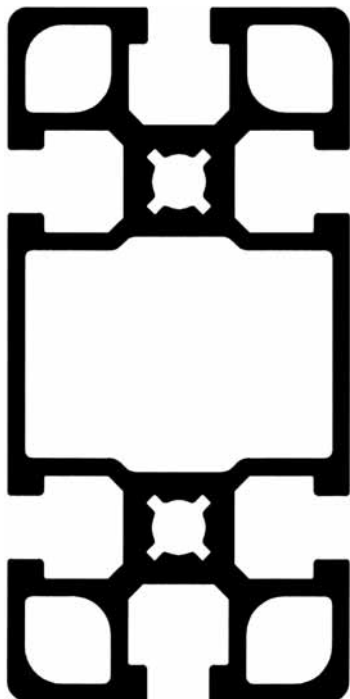

Part No. 20.1032/0

Profile 45 x 90

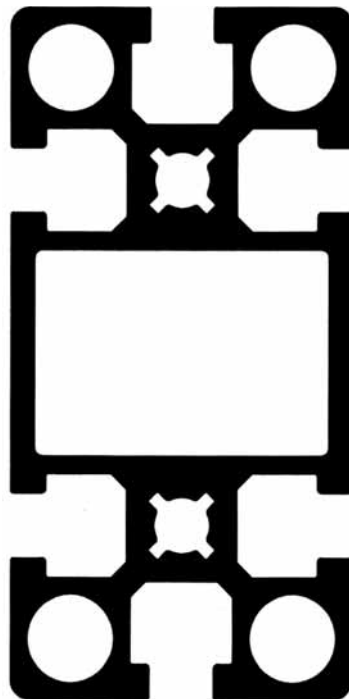

Part No. 20.1009/0

Profile 45 x 90 S

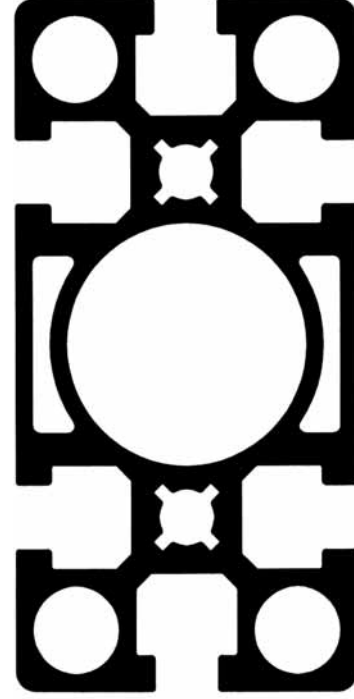

Part No. 20.1017/0

PROFILE SECTIONS

Profile 90 x 90 2G

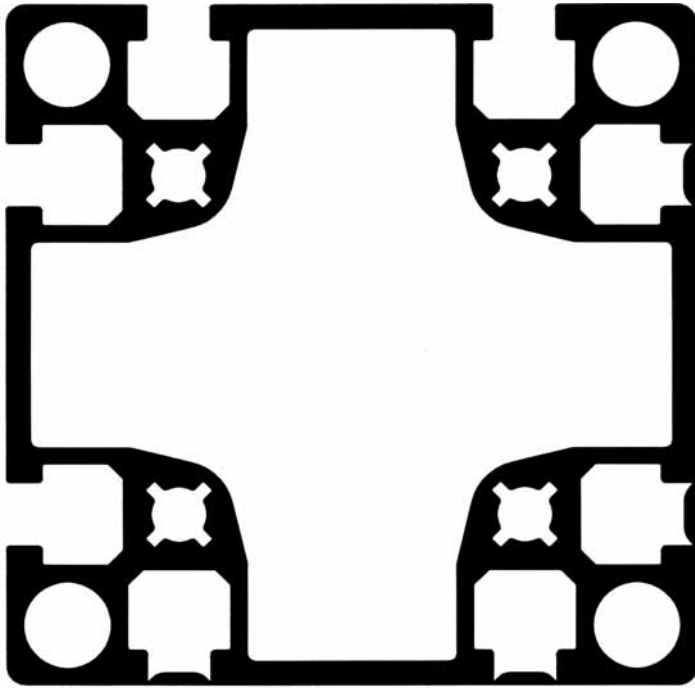

Part No. 20.1044/0

Profile 45 x 135 1G

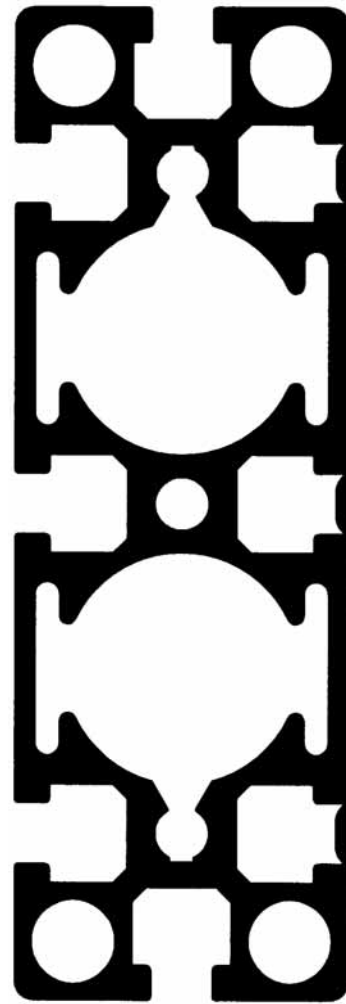

Part No. 20.1078/0

Profile 90 x 90 L

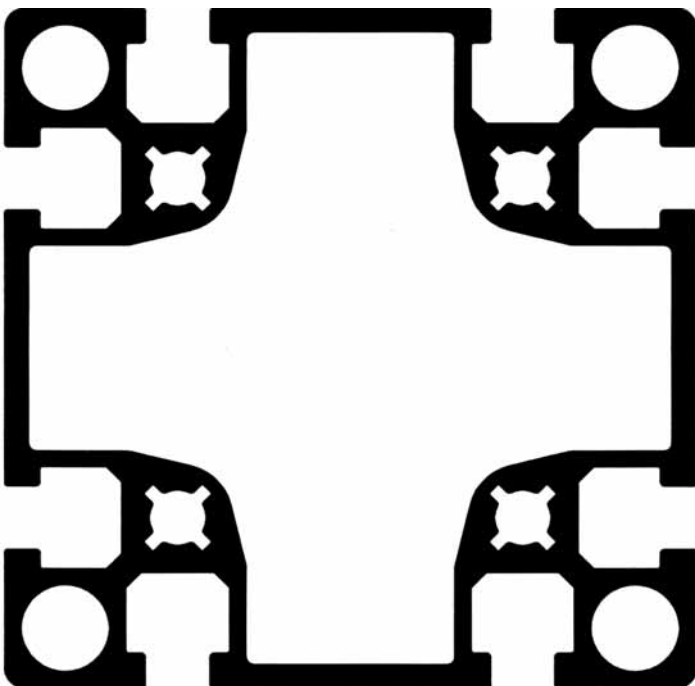

Part No. 20.1010/0

Angular Profile 89 x 89

Part No. 20.1011/0

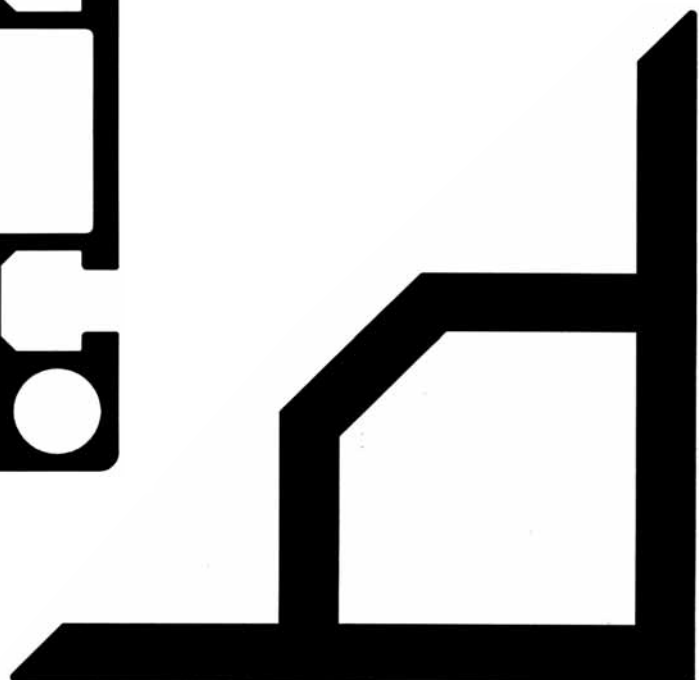

PROFILE SECTIONS

Profile 45 x 135 F

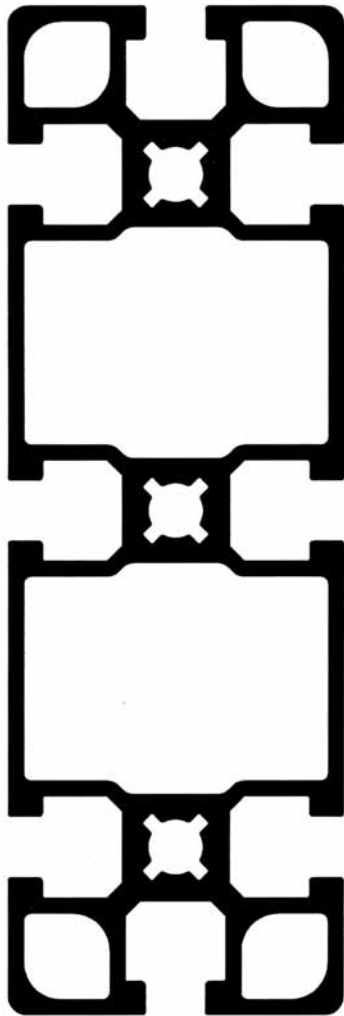

Part No. 20.1087/0

Handle Profile

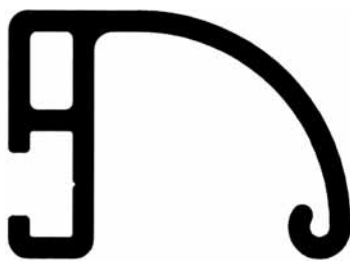

Part No. 20.1045/0

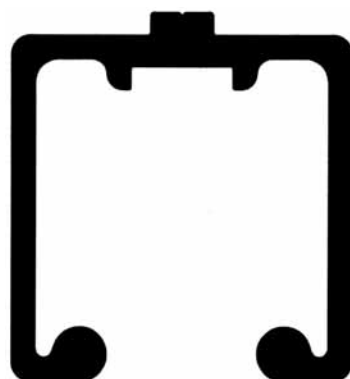

Profile 90 x 90 S

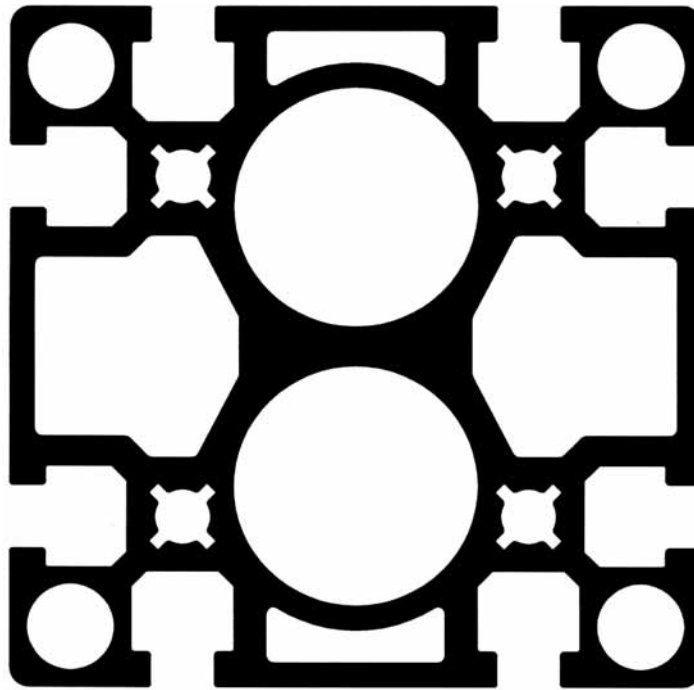

Part No. 20.1019/0

Profile 90 x 90 G

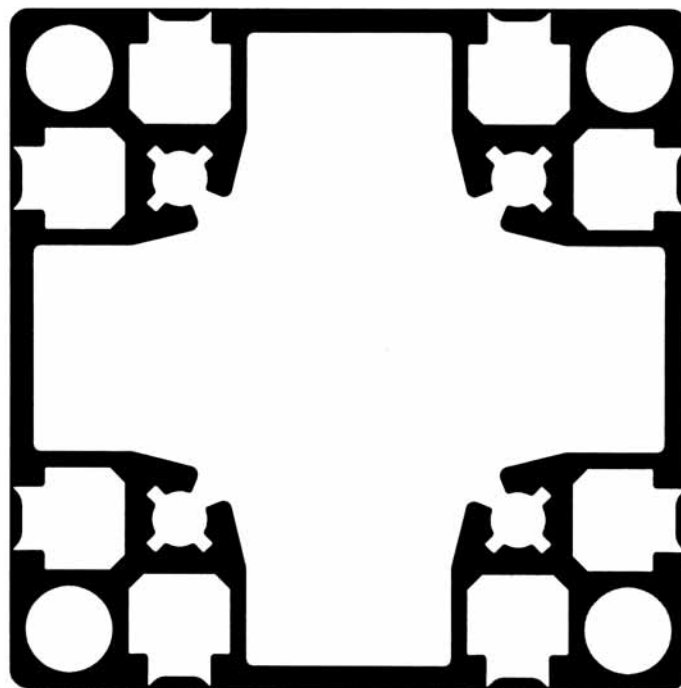

Part No. 20.1082/0

Sliding door Profile

Part No. 20.1038/0

Profile 19 x 270

Part No. 20.1077/0



PROFILE SECTIONS

Profile 32 x 180



Part No. 20.1016/0

Profile 45 x 180 1 G

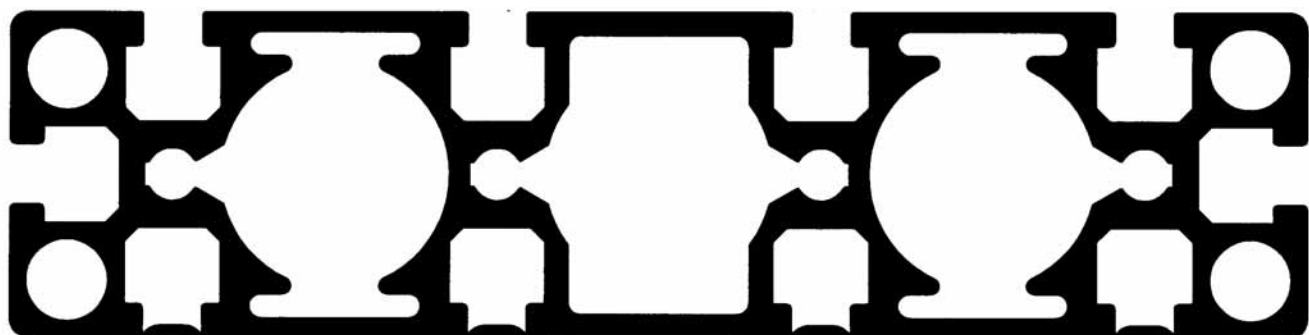

Part No. 20.1079/0

Profile 90 x 180 S

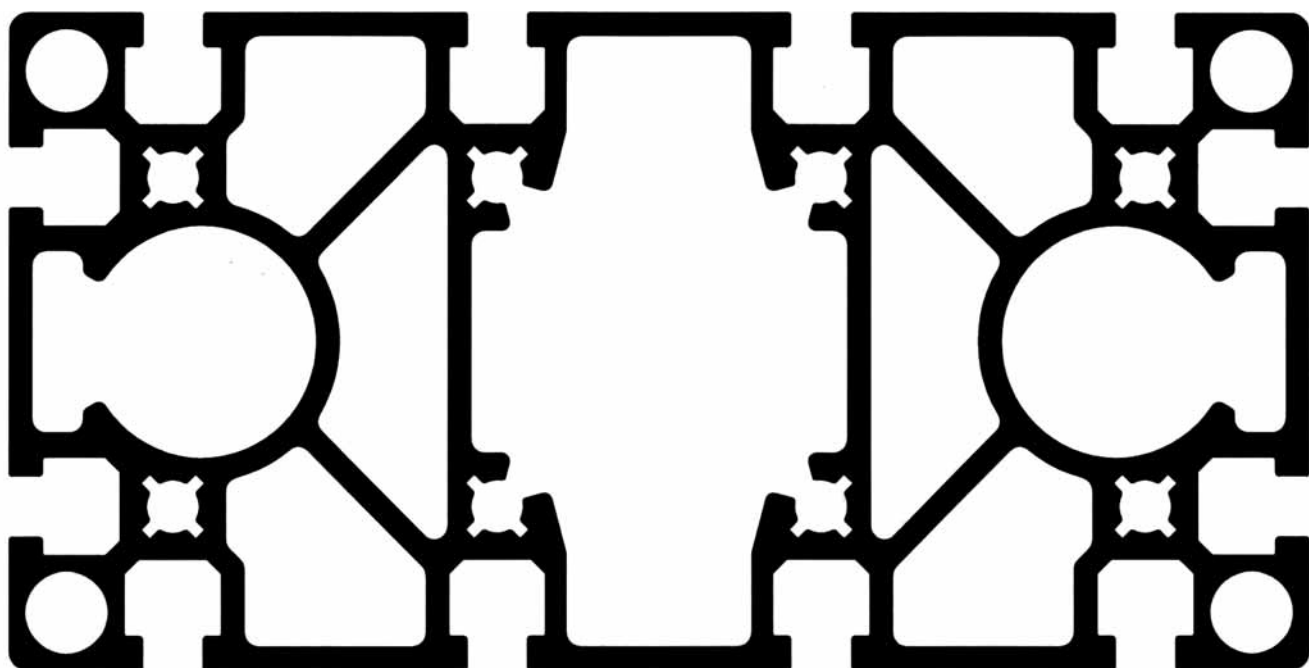

Part No. 20.1013/0

PROFILE SECTIONS

Profile 45/45°

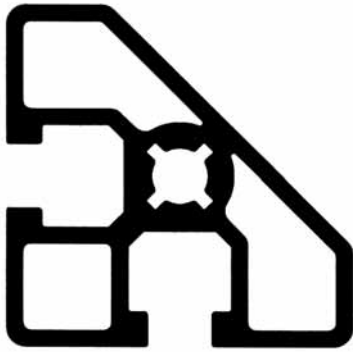

Part No. 20.1029/0

Profile 45 R 90°

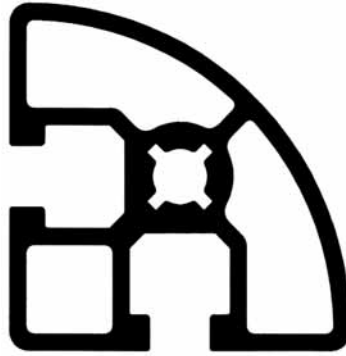

Part No. 20.1069/0

Profile 90 R 90°

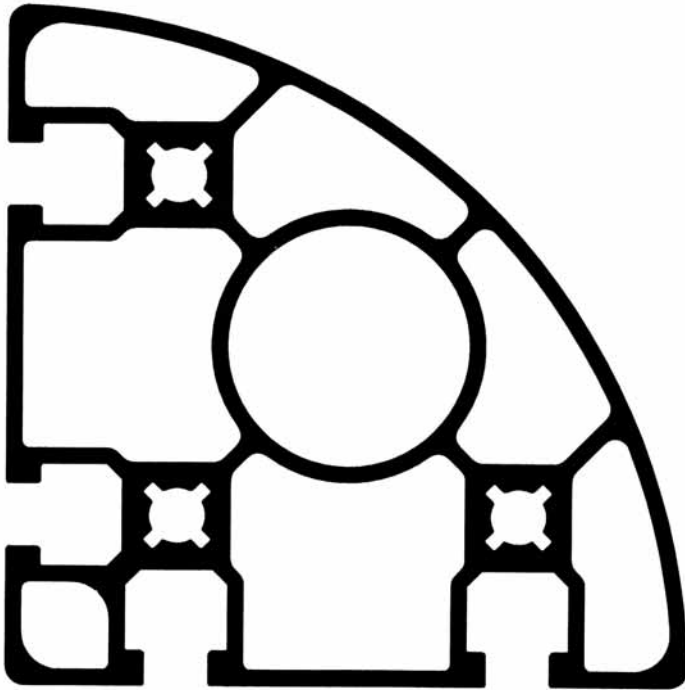

Part No. 20.1091/0

Profile 45 R 30°



Part No. 20.1094/0

Profile 45 R 45°



Part No. 20.1095/0

Profile 45 R 60°



Part No. 20.1096/0

PROFILE 19 X 32

Part. N° 20.1000/0

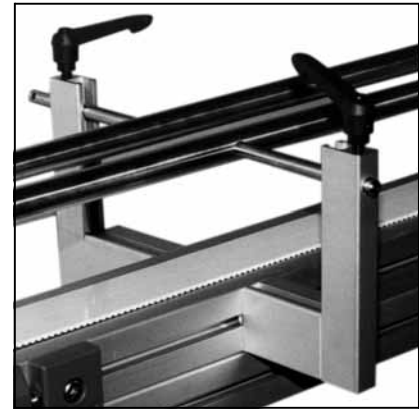
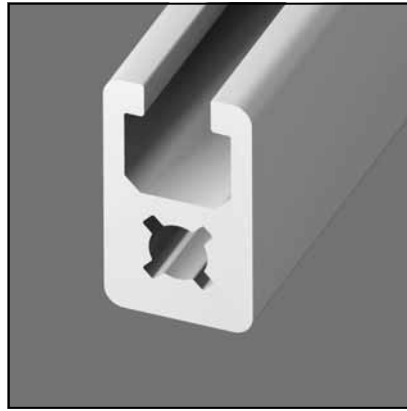
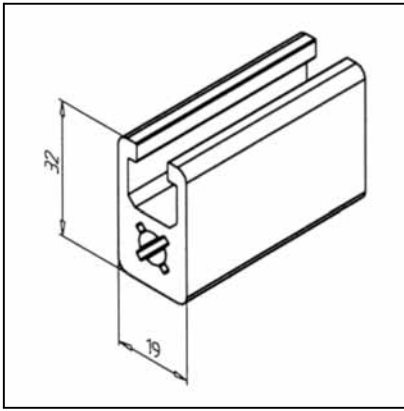

TECHN. DATA / ITEMS SUPPLIED

- Ix =	3,102 cm ⁴
- Iy =	1,526 cm ⁴
- wx =	1,651 cm ³
- wy =	1,606 cm ³
- Weight	0,987 kg/m
- Length	6 m
- Packing unit	60 m

APPLICATIONS

- Light constructions
- Panel frames
- Light supports
- Grip rails

ASSEMBLY

- MiniTec power-lock fastener
- Angle 19
- Bolt-fastener 15
- Screw connection

PROFILE 19 X 45

Part. N° 20.1001/0

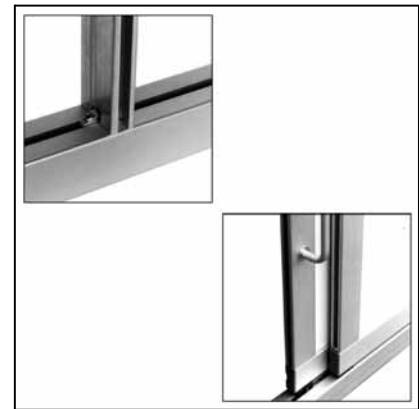
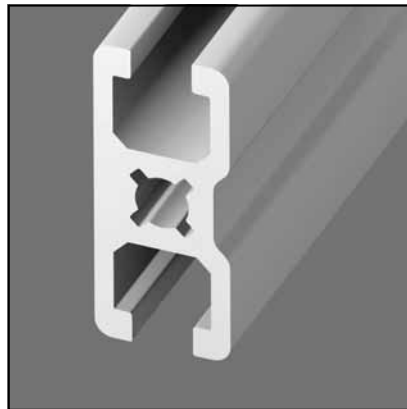
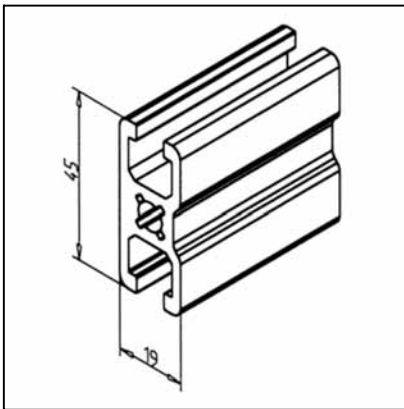

TECHN. DATA / ITEMS SUPPLIED

- Ix =	6,173 cm ⁴
- Iy =	1,843 cm ⁴
- wx =	2,743 cm ³
- wy =	1,836 cm ³
- Weight	1,101 kg/m
- Length	6 m
- Packing unit	60 m

APPLICATIONS

- Light supports, Braces
- Light constructions
- Panel frames
- Shelves

ASSEMBLY

- MiniTec power-lock fastener
- Angle 19
- Bolt-fastener 15
- Screw connection