

FITTING OF PANEL ELEMENTS

There are two assembly modes that have to be distinguished: the mounting of elements into the profile groove and the subsequent attachment of panel elements.

The **mounting of elements into the groove** has to be pre-planned. It is recommended to put together elements to a complete frame that can be fitted into existing constructions. This assembly method is of particular use for large panel elements, corrugated mesh and sealing constructions.

Subsequent mounting of panel elements is easier to perform and causes less damage.

Mounting elements into the profile groove

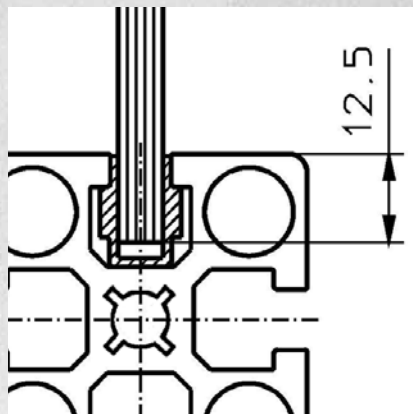

Cover profiles

Panel elements of max. 6 mm thickness can be mounted directly into the profile groove by using a PVC cover profile. Allow an enlargement of panel elements in x and y direction of: +25 mm

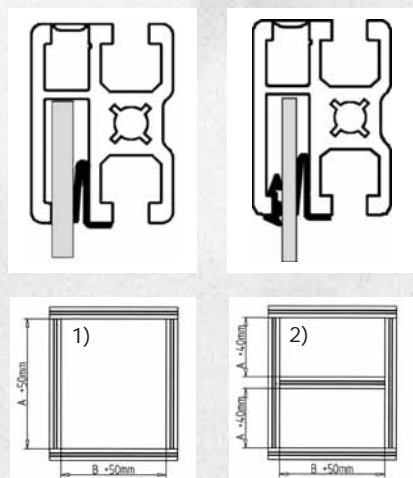

Clamp profile 45 x 32

The clamp profile 45 x 32 combines the properties of the construction profiles and the secure fixing for panel elements of max. 8 mm thickness. This profile is best suited for large elements and corrugated mesh. The ready assembled frames are subsequently fixed to the stand profiles with guard unit fixing angles. Quick removal of the units is ensured.

Allow an enlargement of panel elements in x and y direction of:

- 1) Simple frames: +50 mm
- 2) Frames with intermediate brackets: +40 mm

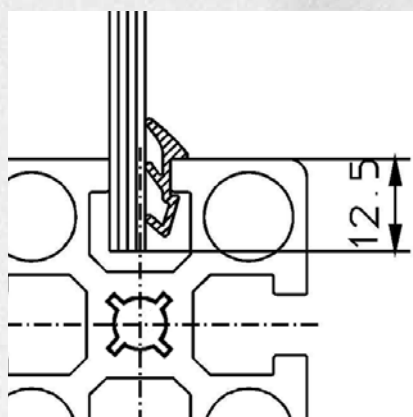

Insert seals

Sheet material, plastic panels, and panes etc. from 2 to 6 mm can easily be mounted and sealed with insert seal 2, 4, 5 and 6. The seals are subsequently pressed into free space between panel element and profile groove with a blunt tool made from wood or plastic. For mounting of sheets < 2 mm use insert seals from both sides of the panel.

Allow an enlargement of panel elements in x and y direction of: +25 mm

Fitting of panels into existing frames

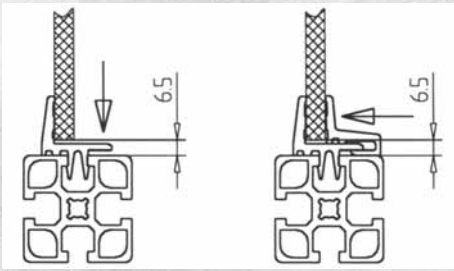

Clamp profiles PVC

For easy fitting of panel elements of all kinds into existing frames without free space between frame and panel. Suitable for panel elements of max. 8 mm, also for corrugated mesh.

For the panel element allow a min of 13 mm reduction in x- and y-direction.

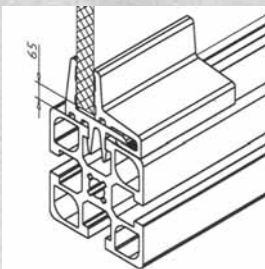

Panel holder

For easy and economic fitting of panel elements into existing frames. The panel holders are of two elements. Best suited for all panel elements of max. 8 mm thickness, except for corrugated mesh. For the panel element allow a min. of 13 mm reduction in x- and y-direction. (6,5 free space between profile surface and panel)

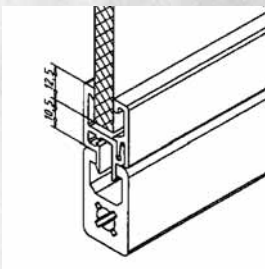
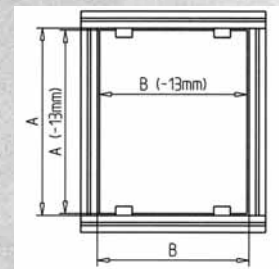

Panel clamp profile

For an easy and cost efficient assembling of panel elements (also for subsequent assembling). No mitre cuts necessary. Suitable for panel elements up to a thickness of 8 mm. For a tight fastening of panel elements < 8 mm use insert seal.

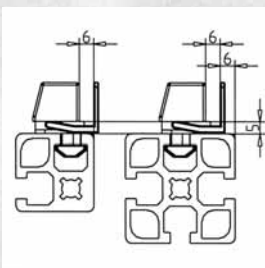
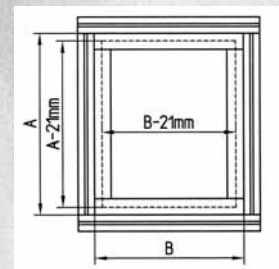

Clamp block

Simple and economical fastening of panel elements. The clamp block consists of block and clip. Suitable for all panel elements from 2 - 6 mm thickness. Not for mesh. For the panel element allow a reduction of 12 mm in x- and y-direction (6 mm free space between profile surface and panel)

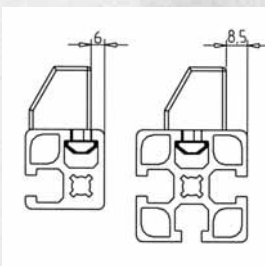
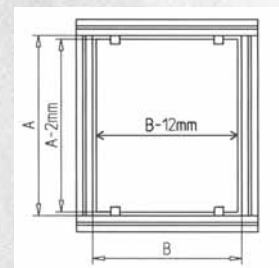

Screw block

Suitable for all kind of panel elements up to 6 mm thickness, except mesh. For the panel element allow a reduction of 2 mm in x- and y-direction (1 mm free space between profile surface and panel)

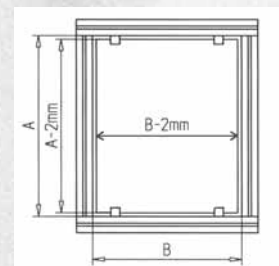

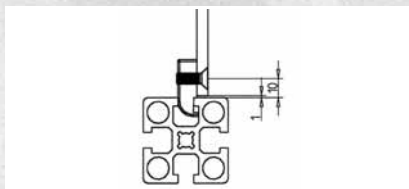

Thread socket

Secure and easy fastening of panel elements of all kinds, except for corrugated mesh. Insert the socket into profile grooves in 300 mm grid. Select screw form and length appropriate to thickness and type of panel element. For the panel element allow a min. of 2 mm reduction in x- and y-direction.

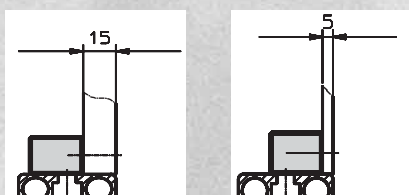
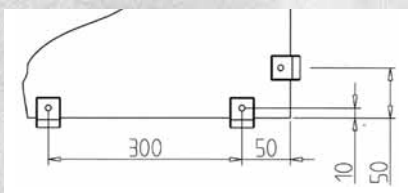

Multiblock

The multiblocks are installed in the clear space of the frame construction at a spacing of approx. 300 mm using cylinder-head screws M6 and rhombus nuts.

Best suited for compound sheet materials. Material of 5-15 mm can be attached bundled. Select screw form and length appropriate to type and thickness of panel element. Bore holes for the attachment screws in the panel elements 6.5 mm in diameter and with 10 mm distance to edge.

For the panel element, allow a min. of 4 mm reduction in the x- and y-direction (- 2 mm space on all sides).

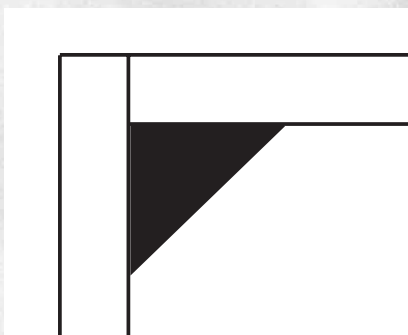
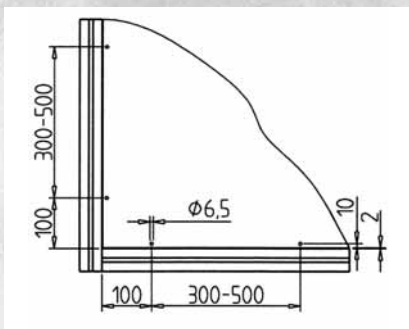

Angles

Fastening of incumbent panel elements for tables, consoles.

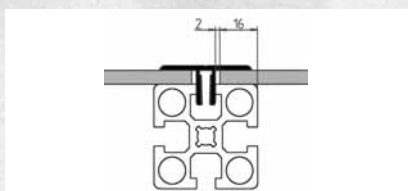

Panel-clamping profile

Suitable for panel elements from 2 to 10 mm.

Insert fixing bores $\varnothing 5,5$ mm for set screw M5 in ~ 250 mm grid. Press into profile groove and fix with set screw M5 x 16.

Best suited for panels, corrugated mesh and expanded metal.

